

CATÁLOGO DE PRODUTOS - LINHA PESADA

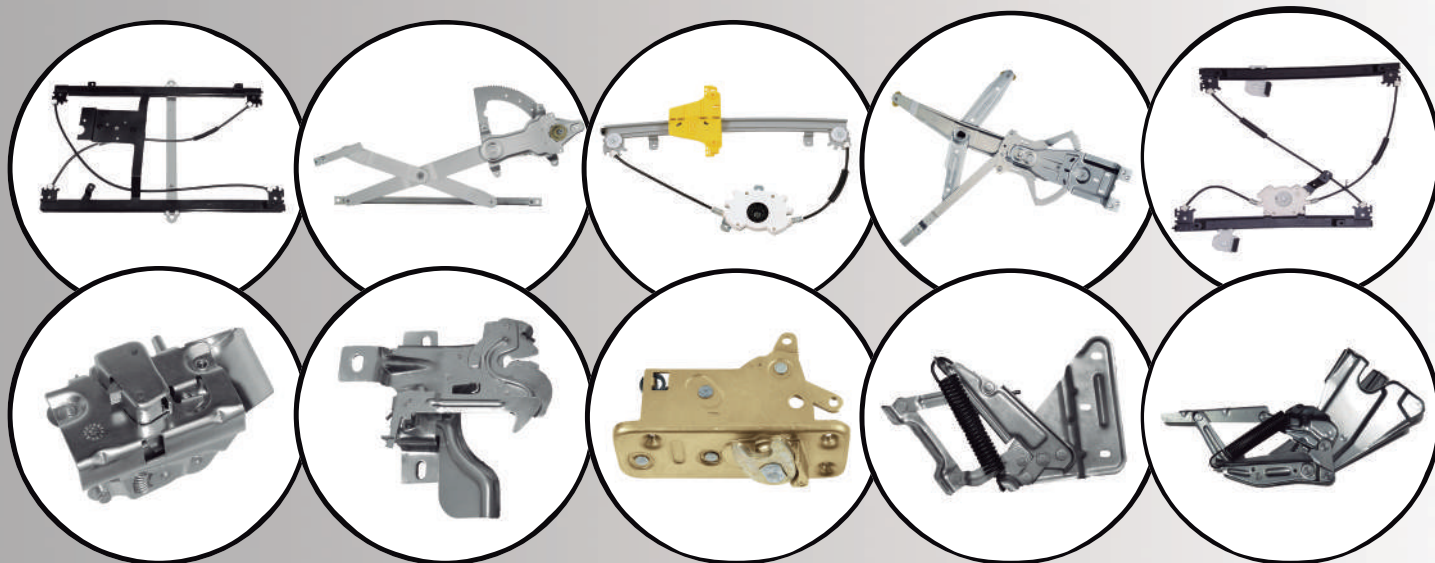

Zinni & Güell Ltda

Indústria de Auto Peças



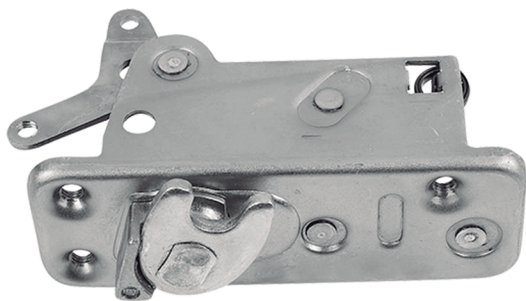

F-2300 E/D
Fechadura
608 1983...1990
N° Orig. A.308.720.70.35 (LE) / A.308.720.71.35 (LD)

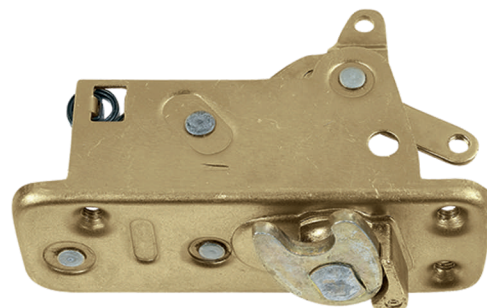

F-2301 E/D
Fechadura
1111-1113-1313-1513-2013-2213 ...1990
N° Orig. A344.720.70.35 (LE) / A344.720.71.35 (LD)

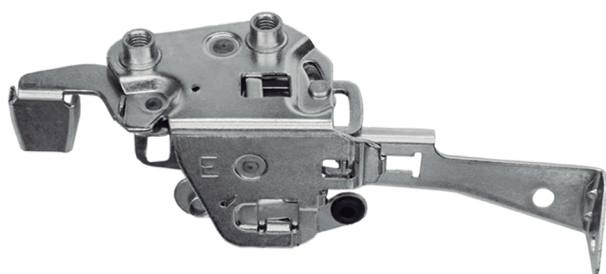

F-2303 E/D
Fechadura interna
709 / 909 ...1996
N° Orig. 688.720.70.35 (LE) / 688.720.71.35 (LD)

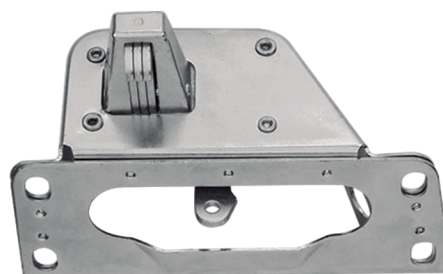

F-2302 I
Fecho do capô inferior
1111-1113-1313-1513-2013-2213 ...1990
N° Orig. 332.880.00.60



F-2302 S
Fecho do capô superior
1111-1113-1313-1513-2013-2213 ...1990
N° Orig. 332.880.00.60

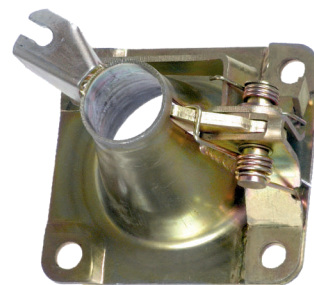

F-2309 I
Fecho do capô inferior
HPN ...2000
N° Orig. A-384.880.76.60

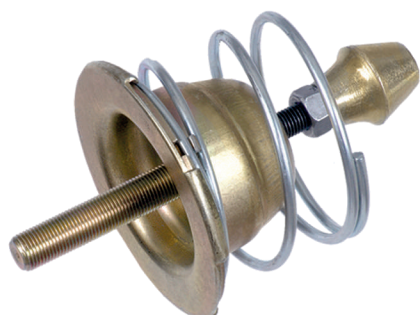

F-2309 S
Fecho do capô superior
HPN ...2000
N° Orig. A-384.880.76.60

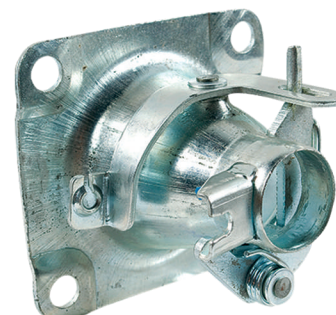

F-2306 I
Fecho do capô inferior
HPN 2001...
N° Orig. A-694.880.02.60

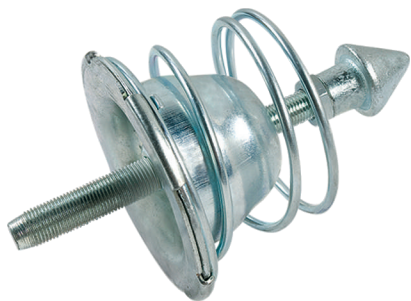

F-2306 S
Fecho do capô superior
HPN 2001...
N° Orig. A-694.880.01.60

MECÂNICA

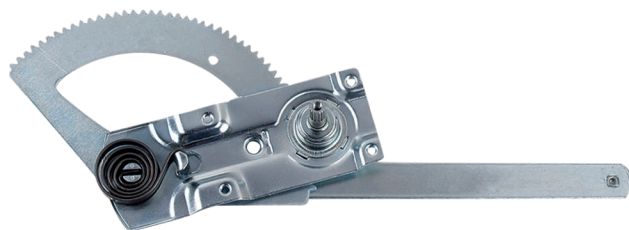

R-2122 E/D
Máquina Reguladora
1111-1113-1313-1513-2013-
2213 1983...1990 Pino Longo
N° Orig. 331.725.70.02 (LE) / 331.725.71.02 (LD)

MECÂNICA

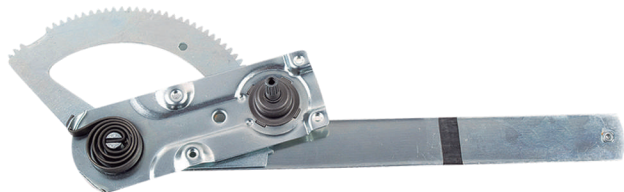

R-2124 E/D
Máquina Reguladora
MB Zetros / Unimog 1991...
Pino Longo - Exportação
N° Orig. 381.725.00.02 (LE) / 381.725.01.02 (LD)

MECÂNICA

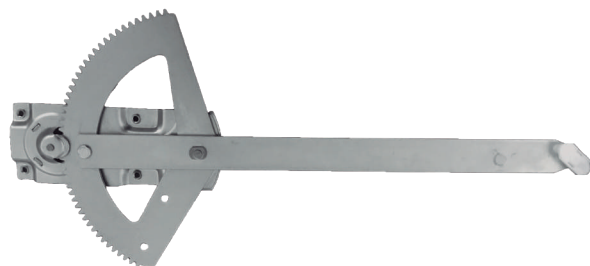

R-2120 E/D
Máquina Reguladora
709 / 1935 / LS 1938 / L 1218 /
L 1418 2001...
N° Orig. 688.720.75.46 (LE) / 688.720.76.46 (LD)

MECÂNICA

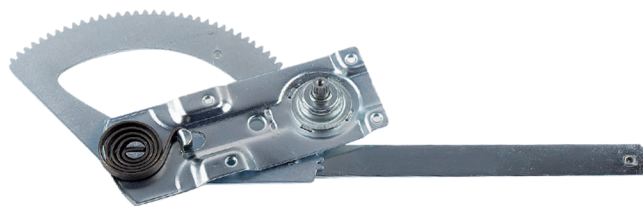

R-2121 E/D
Máquina Reguladora
1111-1113-1313-1513-2013-
2213 1973...1982 Pino Curto
N° Orig. 344.768.00.01 (LE) / 344.768.01.01 (LD)

MECÂNICA



R-2125 E/D
Máquina Reguladora
608 1983...1990
N° Orig. A308.670.7203 (LE) / A308.670.7303 (LD)

MECÂNICA

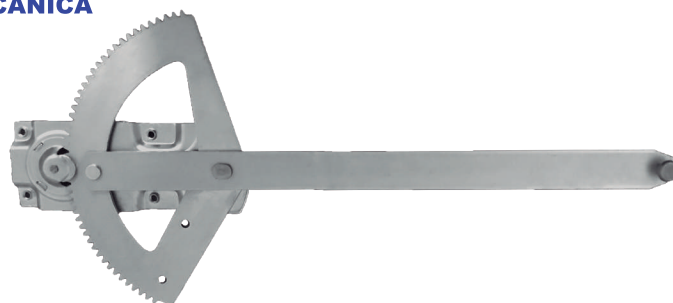

R-2123 E/D
Máquina Reguladora
507 / 709 / 809 / 811 /
909 / 1938 1991...2000 Pino Longo
N° Orig. 688.720.70.46 (LE) / 688.720.71.46 (LD)

MECÂNICA

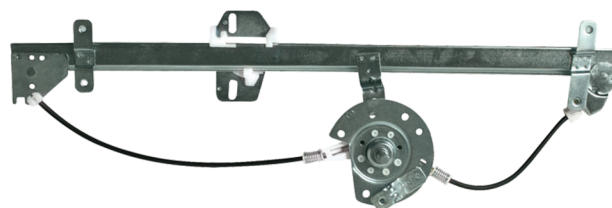

R-2307 E/D
Máquina Reguladora
1938 S / Atego / Axor - Pino Curto
N° Orig. 973.720.01.46 (LE) / 973.720.02.46 (LD)



MECÂNICA

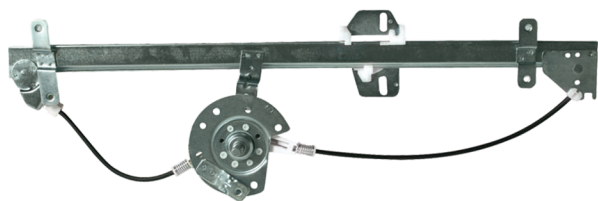

R-2314 E/D
Máquina Reguladora
1938 S / Atego / Axor -
Pino Longo
 N° Orig. 973.720.01.46 (LE) / 973.720.02.46 (LD)

MECÂNICA

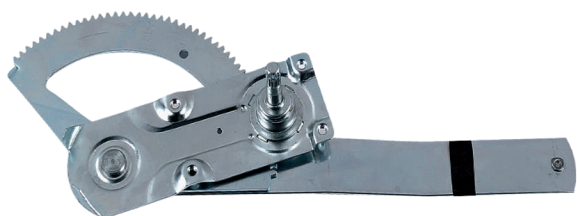

R-2305 E/D
Máquina Reguladora
Alemão - Exportação
 N° Orig. N/A (LE) / N/A (LD)

ELÉTRICA

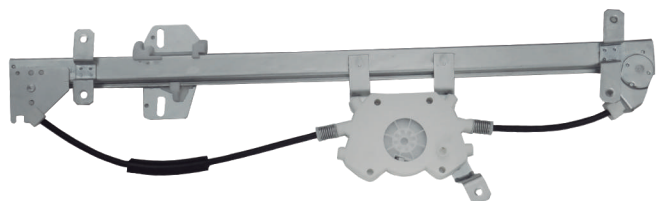

R-2312 E/D
Máquina Reguladora
1938 S / Atego / Axor - 24V
 C/ Motor - S/ Motor
 Fixação Motor Mabuchi - (Motor invertido)
 N° Orig. 979.720.03.46 (LE) / 979.720.04.46 (LD)



ELÉTRICA



R-2128 E/D
Máquina Reguladora
HPN 709 / 1935 / Atron 2001... 12/24V
 C/ Motor - S/ Motor
 Fixação Motor Mabuchi - (Motor invertido)
 N° Orig. 696.720.02.46 (LE) / 696.720.01.46 (LD) 12V
 N° Orig. 696.720.04.46 (LE) / 696.720.05.46 (LD) 24V

MECÂNICA

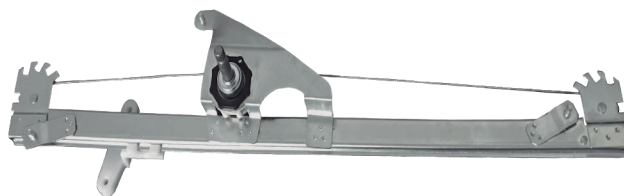

R-2308 E/D
Máquina Reguladora
Accelo 815 / 1016 2012...
 N° Orig. 979.720.11.46 (LE) / 979.720.12.46 (LD)

ELÉTRICA

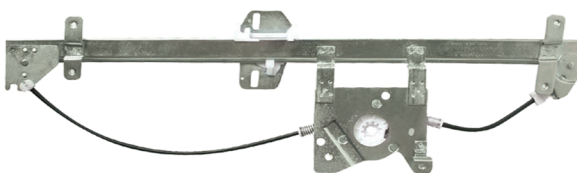

R-2310 E/D
Máquina Reguladora
1938 S / Atego / Axor
 C/ Motor - S/ Motor
 Fixação Motor Original
 N° Orig. 979.720.03.46 (LE) / 979.720.04.46 (LD)

ELÉTRICA

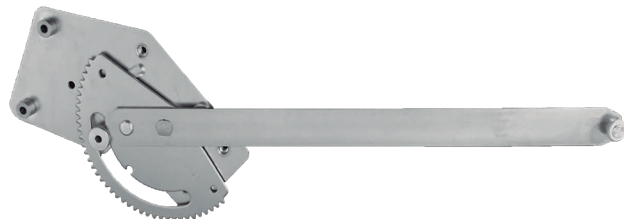

R-2126 E/D
Máquina Reguladora
HPN 709 / 1935 1991...2000 - 12/24V
 C/ Motor - S/ Motor
 Fixação Motor Mabuchi - (Motor invertido)
 N° Orig. A384.720.70.46 (LE) / A384.720.71.46 (LD)

ELÉTRICA

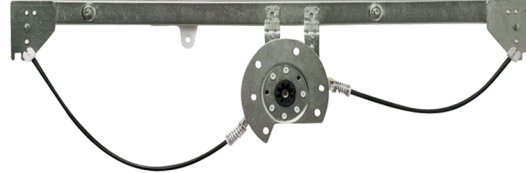

R-2311 E/D
Máquina Reguladora
Accelo 715 - 12V / 915 - 24V ...2011
 C/ Motor - S/ Motor
 Fixação Motor Mabuchi - (Motor invertido)
 N° Orig. 979.720.01.46 SM (LE) / 979.720.02.46 SM (LD) 12V
 N° Orig. 979.720.70.46 SM (LE) / 979.720.71.46 SM (LD) 24V

MERCEDES BENZ - PESADO



ELÉTRICA

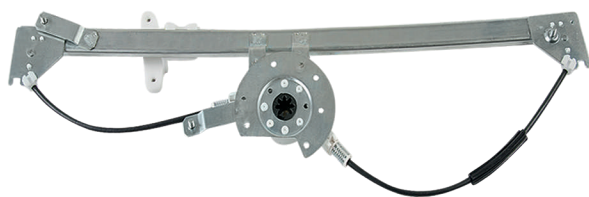

R-2313 E/D

Máquina Reguladora

Accelo 815 / 1016 2012... 12/24V

C/ Motor - S/ Motor

Fixação Motor Mabuchi - (Motor invertido)

Nº Orig. 979.720.08.46 (LE) / 979.720.09.46 (LD)

IVECO - PESADO

MECÂNICA

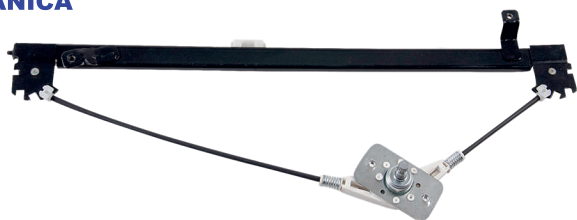

R-1424 E/D

Máquina Reguladora

Stralis / Eurocargo / Tector /

Cavallino 320 1998... - Todos

Nº Orig. 2.997.186 (LE) / 2.997.185 (LD)



ELÉTRICA



R-1445 E/D

Máquina Reguladora

Stralis / Eurocargo / Tector /

Cavallino 320 1998...2008 24V

C/ Motor - S/ Motor

Fixação Motor Mabuchi

Nº Orig. 2.997.196LH (LE) / 2.997.195RH (LD)



MECÂNICA

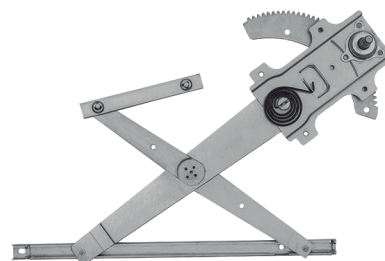

R-1501 E/D

Máquina Reguladora

Vertis DNT. 2011...

Nº Orig. 594.989.12.63 (LE) / 594.989.12.22 (LD)

ELÉTRICA

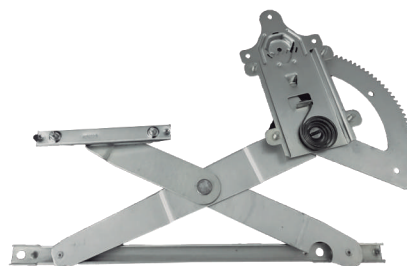

R-1446 E/D

Máquina Reguladora

Vertis 2011... 12/24V

C/ Motor - S/ Motor

Fixação Motor Mabuchi

Nº Orig. 594.989.11.65 (LE) / 594.989.11.64 (LD)

MECÂNICA



R-2601 E/D
Máquina Reguladora
L75 / L76 1970...1974 - C/Quebra Vento
 N° Orig. 66.735 (LE) / 66.736 (LD)

MECÂNICA

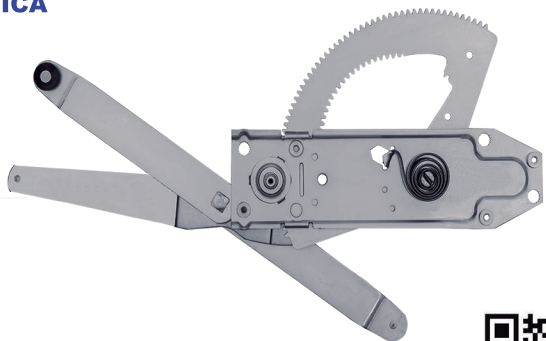

R-2603 E/D
Máquina Reguladora
T/R 112 1981...1987
 N° Orig. 296.429 (LE) / 296.430 (LD)



MECÂNICA

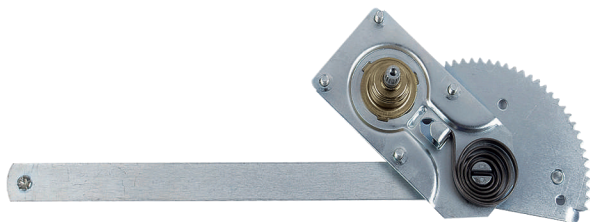

R-2605 E/D
Máquina Reguladora
LK 140 / 141 1988...
 N° Orig. 187.719 (LE) / 187.720 (LD)

ELÉTRICA

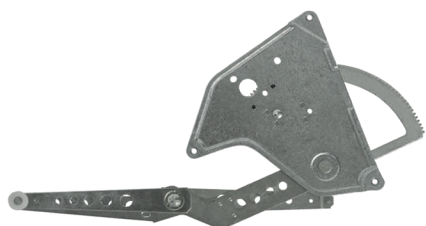

R-2608 E/D
Máquina Reguladora
Série 3 / R112 / R113 /
T112 / T113 1981...1997 24V
 C/ Motor - S/ Motor
 Fixação Motor Original
 N° Orig. 376.673 (LE) / 376.674 (LD)



MECÂNICA

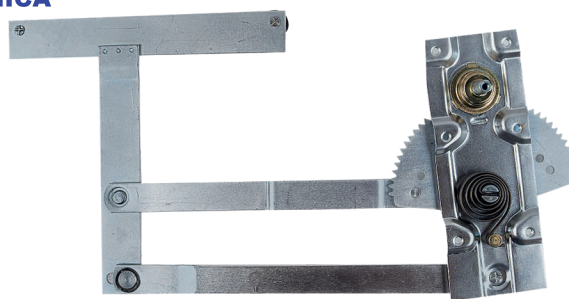

R-2602 E/D
Máquina Reguladora
L110 / L111 1975...1980 - S/Quebra Vento
 N° Orig. 236.255 (LE) / 236.256 (LD)

MECÂNICA



R-2604 E/D
Máquina Reguladora
T/R 113 1988...1997
 N° Orig. 524.783 (LE) / 524.784 (LD)



MECÂNICA



R-2606 E/D
Máquina Reguladora
Série 4 / 5 / 6 T/R/P/G 1998...
 N° Orig. 1.366.847 (LE) / 1.366.848 (LD)



ELÉTRICA



R-2607 E/D
Máquina Reguladora
Série 4 114 / 124 / T/R/P/G 1998... 24V
 C/ Motor - S/ Motor
 Fixação Motor Original
 N° Orig. 1.442.294 (LE) / 1.442.295 (LD)



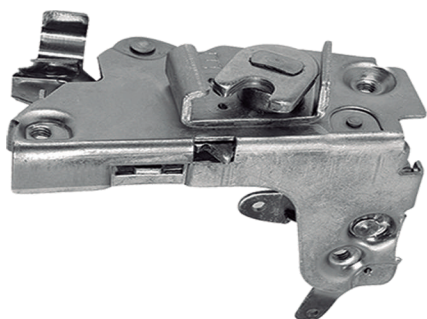

F-2915 E/D
Fechadura
NL 10 / NL12 / EDC 1992...1999
Cabine Longa
 N° Orig. 8.123.611 (LE) / 8.123.612 (LD)

MECÂNICA

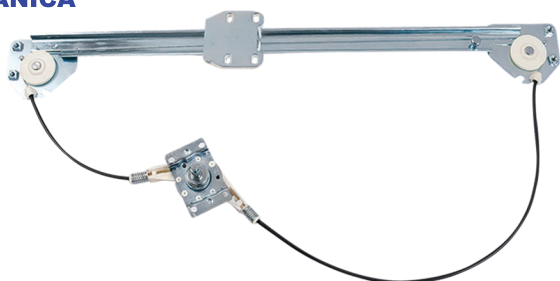

R-2611 E/D
Máquina Reguladora
NL 10 / NL12 / EDC 1992...1999
Cabine Longa
 N° Orig. 8.123.657 (LE) / 8.123.658 (LD)

MECÂNICA

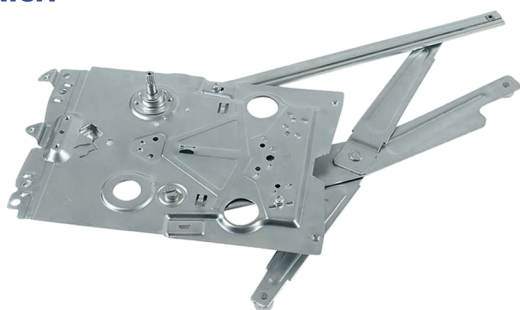

R-2617 E/D
Máquina Reguladora
FH12 / FH13 / FM 1994...
 N° Orig. 31.76.541 (LE) / 31.76.542 (LD)

ELÉTRICA



R-2613 E/D
Máquina Reguladora
NL 10 / NL12 / EDC 1992...1999
Cabine Longa 24V
 C/ Motor - S/ Motor
 Fixação Motor Mabuchi
 N° Orig. 8.123.551 (LE) / 8.123.550 (LD)

MECÂNICA

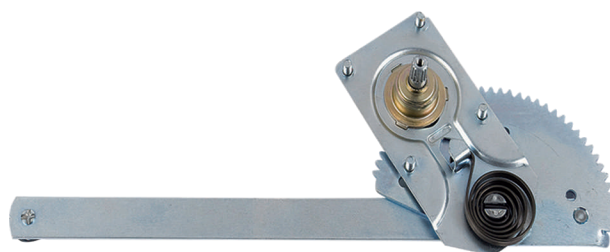

R-2610 E/D
Máquina Reguladora
N / NL ...1989 Cabine Curta
 N° Orig. 6.889.223 (LE) / 6.889.224 (LD)

MECÂNICA

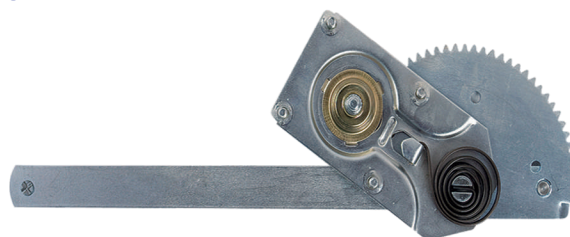

R-2612 E/D
Máquina Reguladora
NL10 / NL12 1990...1994
Braço - Cabine Normal
 N° Orig. 8.123.247 (LE) / 8.123.248 (LD)

MECÂNICA

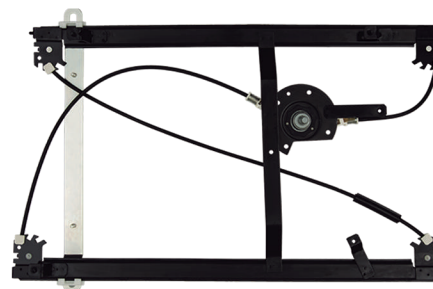

R-2616 E/D
Máquina Reguladora
VM 2004...Todos
 N° Orig. 20.557.548 (LE) / 20.557.550 (LD)



ELÉTRICA

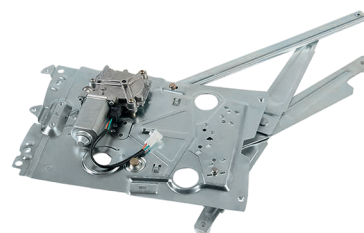

R-2615 E/D
Máquina Reguladora
FH12 / FH13 / FM 1994... 24V
 C/ Motor - S/ Motor
 Fixação Motor Original - Todos
 N° Orig. 3.176.545 (LE) / 3.176.546 (LD)

VOLVO - PESADO



ELÉTRICA

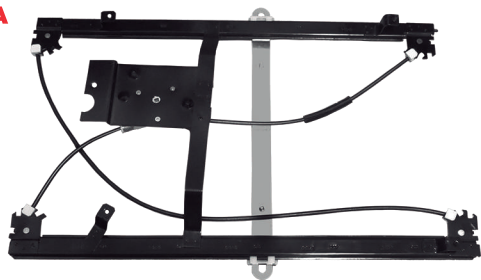

R-2618 E/D

**Máquina Reguladora
VM 2004... Todos**

C/ Motor - S/ Motor

Fixação Motor Original

Nº Orig. 20.557.552 (LE) / 20.557.554 (LD)



ELÉTRICA

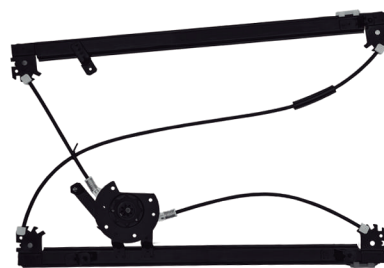

R-2614 E/D

**Máquina Reguladora
VM 2004... Todos 24V**

C/ Motor - S/ Motor

Fixação Motor Mabuchi

Nº Orig. 20.557.552 (LE) / 20.557.554 (LD)



GENERAL MOTORS - PESADO

MECÂNICA

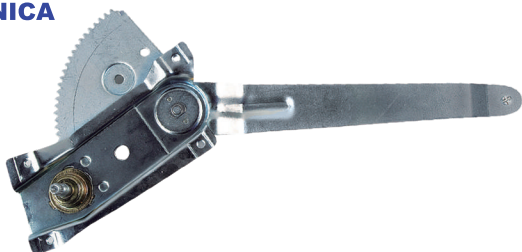

R-3114 E/D

Máquina Reguladora

Pick-up C10 / D10 /

Pick-up ...1985

Nº Orig. 73.200.91 (LE) / 73.200.92 (LD)

MECÂNICA

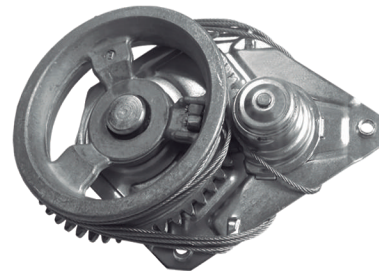

R-3116 E/D

Máquina Reguladora

Pick-up D20 1985...1990

Nº Orig. 94.637.551 (LE) / 94.637.552 (LD)

MECÂNICA

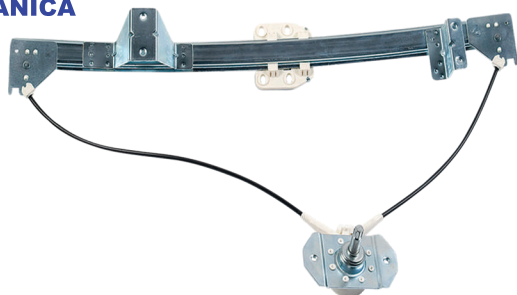

R-3346 E/D

Máquina Reguladora

Bonanza / Veraneio / A/C / D20A /

D40 / D12000 DNT. 1991...

Nº Orig. 52.255.121 (LE) / 52.255.122 (LD)

MECÂNICA

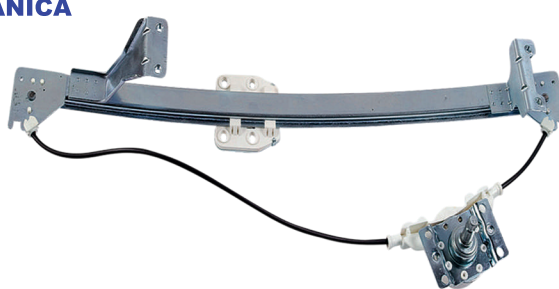

R-3347 E/D

Máquina Reguladora

Bonanza / Veraneio / A/C / D20A /

D40 / D12000 TRS. 1991...

Nº Orig. 52.255.125 (LE) / 52.255.126 (LD)

MECÂNICA

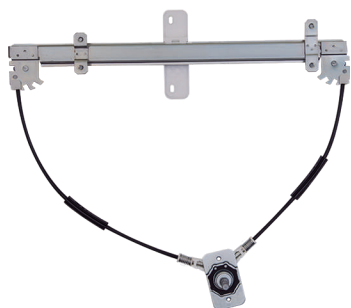

R-4162 E/D
Máquina Reguladora
Worker / Delivery / Titan / Tractor
1980...1989 - Pino mais curto c/ furo
 N° Orig. TOO 837.501 (LE) / TOO 837.502 (LD)



MECÂNICA

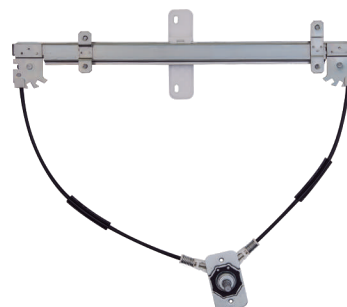

R-4160 E/D
Máquina Reguladora
Worker / Delivery / Titan / Tractor
1990...1996 - Pino curto c/ furo
 N° Orig. TF3.837.501 (LE) / TF3.837.502 (LD)



MECÂNICA

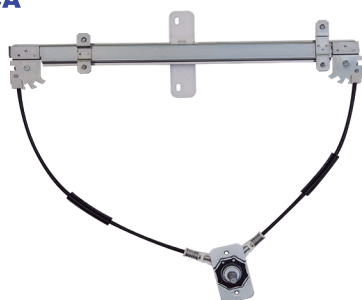

R-4161 E/D
Máquina Reguladora
Worker / Delivery / Titan /
Tractor 1997...2000 - Pino médio c/ trava
 N° Orig. 2RD 837.501 (LE) / 2RD 837.502 (LD)



MECÂNICA

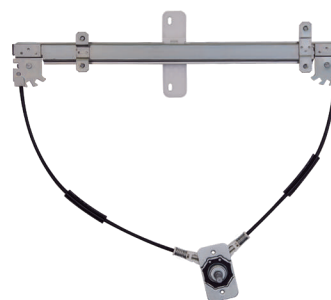

R-4163 E/D
Máquina Reguladora
Worker / Delivery / Titan /
Tractor 2001... - Pino longo c/ trava
 N° Orig. 2VC.837.501 (LE) / 2VC.837.502 (LD)



MECÂNICA



R-4188 E/D
Máquina Reguladora
Constellation 2005...
 N° Orig. 2R2.837.397 (LE) / 2R2.837.398 (LD)

ELÉTRICA

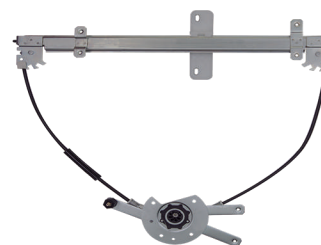

R-4195 E/D
Máquina Reguladora
Worker / Delivery / Titan /
Tractor 1980... - Todos 12/24V
 C/ Motor - S/ Motor
 Fixação Motor Mabuchi
 N° Orig. TF3.837.501.SM (LE) / TF3.837.502.SM (LD)



ELÉTRICA

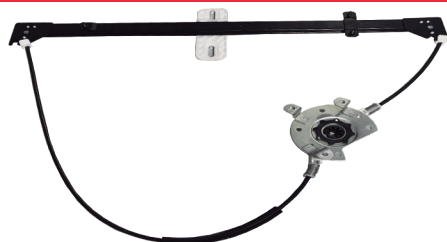

R-4196 E/D
Máquina Reguladora
Tractor Constellation 2007...
13180 / 15180 / 17250 / 19320 / 24250 / 26260 24V
 C/ Motor - S/ Motor
 Fixação Motor Mabuchi - (Motor invertido)
 N° Orig. 2R2.837.399 (LE) / 2R2.837.400 (LD)



MECÂNICA

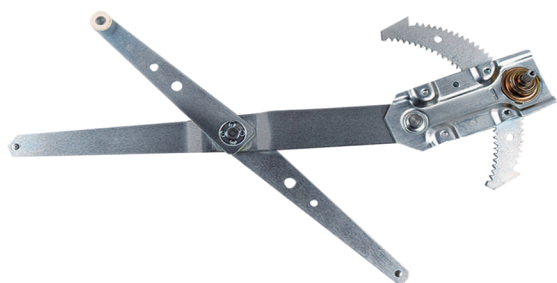

R-5148 E/D
Máquina Reguladora
Cargo 1981...
 N° Orig. 81DBE23201AJ (LE) / 81DBE23200AJ (LD)

MECÂNICA

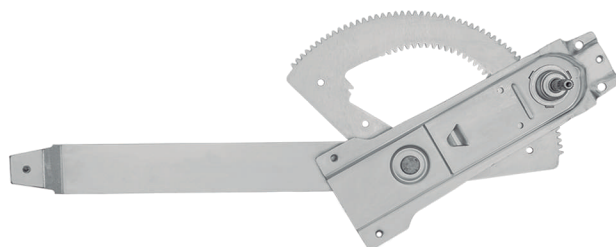

R-5149 E/D
Máquina Reguladora
F-4000 Sapão 1992...1999
 N° Orig. T71.837.501.D (LE) / T71.837.502.D (LD)

MECÂNICA

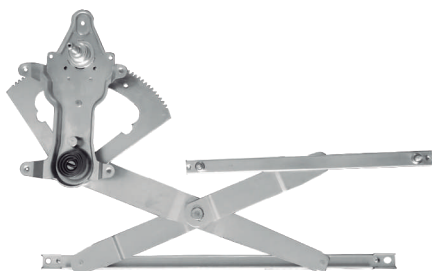

R-5247 E/D
Máquina Reguladora
F-250 1998...2012 / F-350 1998... /
F-4000 1998... - 4P - TRS.
 N° Orig. 8C3Z2627001A (LE) / 8C3Z2627000A (LD)

ELÉTRICA

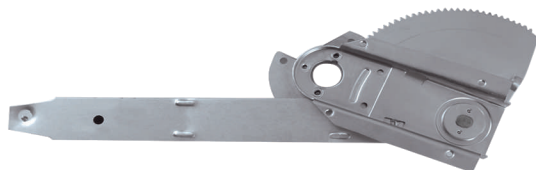

R-5222 E/D
Máquina Reguladora
F-600 / F-11000 / F-4000 1972...1991
 C/ Motor - S/ Motor
 Fixação Motor Mabuchi - (Motor invertido)
 N° Orig. 89TU.81234W01B (LE) / 89TU.81234W00B (LD)

MECÂNICA

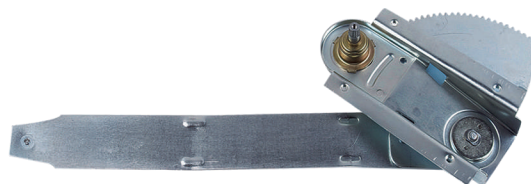

R-5141 E/D
Máquina Reguladora
F-600 / F-11000 / F-4000 1972...1991
 N° Orig. BC3C.812.3201.A (LE) / BD3C.812.3200.A (LD)

MECÂNICA



R-5226 E/D
Máquina Reguladora
F-250 / F-350 / F-4000 2000...
 N° Orig. XC3Z.252.3201.AA (LE) / XC3Z.252.3200.AA (LD)

ELÉTRICA



R-5233 E/D
Máquina Reguladora
Cargo 1981...2013 12/24V
 C/ Motor - S/ Motor
 Fixação Motor Mabuchi
 N° Orig. 81DBE23201AJ (LE) / 81DBE23200AJ (LD)

ELÉTRICA

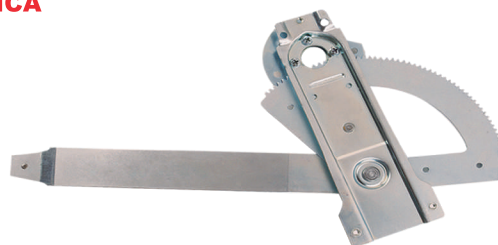

R-5229 E/D
Máquina Reguladora
F-4000 Sapão 1992...1999
 C/ Motor - S/ Motor
 Fixação Motor Mabuchi - (Motor invertido)
 N° Orig. 2SA.837.501A (LE) / 2SA.837.502A (LD)

FORD - PESADO



ELÉTRICA



R-5235 E/D

Máquina Reguladora

F-250 / F-350 / F-4000 DNT. 2000... 12V

C/ Motor - S/ Motor

Fixação Motor Mabuchi

N° Orig. XC3Z.25.23.201.BA (LE) / XC3Z.2523.200.BA (LD)

ELÉTRICA



R-5248 E/D

Máquina Reguladora

F-250 / F-350 / F-4000 TRS. 2000... 12V

C/ Motor - S/ Motor

Fixação Motor Mabuchi

N° Orig. 8C3.Z26.270.01 (LE) / 8C3.Z26.270.00B (LD)

ELÉTRICA

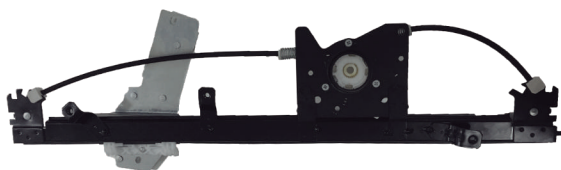

R-5236 E/D

Máquina Reguladora

Cargo C-815 / C-1119 2013 ... 12/24V

C/ Motor - S/ Motor

Fixação Motor Mabuchi

N° Orig. EC45-702.320.1BB (LE) / EC45-702.320.0BB (LD)

ELÉTRICA

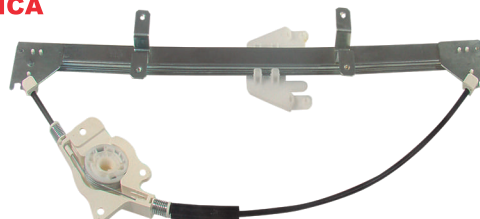

R-5237 E/D

Máquina Reguladora

Cargo 1319 / 1519 / 1719 / 1723 /

1719 / 1933 / 2423 / 2429 / 2623 /

2629 / 3133 / 2042 / 2842 2011...

C/ Motor - S/ Motor

Fixação Motor Original

N° Orig. 3C4.6E2.320.1BE (LE) / 3C4.6E2.320.0BE (LD)

ELÉTRICA

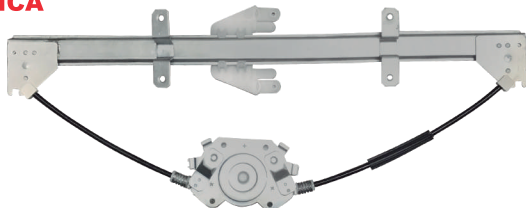

R-5249 E/D

Máquina Reguladora

CARGO 2011...

C/ Motor - S/ Motor

Fixação Motor Mabuchi

N° Orig. 3C46E23201BE (LE) / 3C46E23200BE (LD)

TOYOTA - PESADO

MECÂNICA

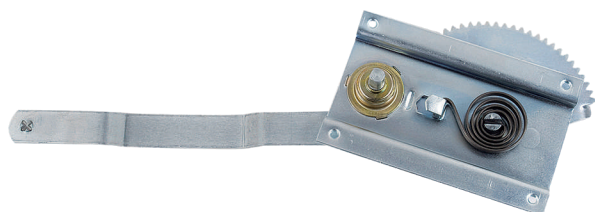

R-2620 E/D

Máquina Reguladora

Bandeirante ...1981 - Pino quadrado

N° Orig. 6980.298.001B (LE) / 6980.198.001B (LD)

MECÂNICA

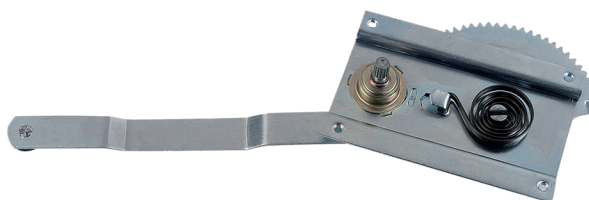

R-2621 E/D

Máquina Reguladora

Bandeirante 1982...1983 - Pino estriado

N° Orig. 6980.298.002A (LE) / 6980.198.002A (LD)

MECÂNICA

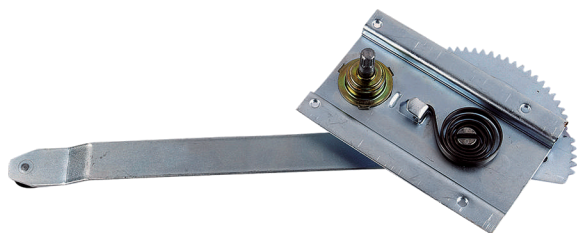

R-2622 E/D

Máquina Reguladora

Bandeirante 1984... - Pino estriado

Nº Orig. 6.980.298.003 (LE) / 6.980.198.003 (LD)